

Your success counts

Single stream Flow & Energy Computer for water and saturated / superheated steam



Application examples: Boiler



Heat exchanger



Field mount example

The C581 is a powerful Flow and Energy Computer for single stream water and saturated / superheated steam applications. The comprehensive and rugged enclosure combines easy installation and operation, resulting in cost reduction.

It works with any pulse, differential pressure or analog signal generating measurement device.

Advantages

- Robust IP66/67, Type4X aluminium field enclosure, withstands extreme weather and industrial conditions.
- Large, versatile display with bright backlight, all info at a glance.
- Easy-to-operate with 6 rugged industrial silicone buttons.
- User-friendly operation and configuration via the keypad and display or with the free available configuration software.

Features

- Calculates mass flow, volumetric flow and power at actual conditions.
- Calculates totalized values for volume, mass and energy.
- Determines density and enthalpy according to IAPWS.
- Data logging of process parameters and calculated values.
- 11 point linearization for all inputs.
- Ability to process various flow inputs: pulse (pending), (stacked) differential pressure or other 4 - 20mA signals.
- 4 - 20mA inputs for pressure and temperature sensors.
- Pt100 and Pt500 for temperature input.
- 2 status inputs.
- 2 analog outputs, 2 digital outputs, 2 relay outputs.
- 3 communication ports: RS485, RS232 and mini-USB.
- Power: 100 - 230V AC or 16 - 27V DC.
- Ambient temp.: -40°C to +55/+70 °C (-40°F to +131/+158°F).

Introduction

The C581 flow and energy computer measures the actual flow, temperature and pressure and uses the IAPWS determinations to calculate the energy, mass and volumetric flow. The linearization greatly enhances accuracy in any flow range. The large logging register contains all measured and calculated values. The robust IP66/67, Type4X aluminum field enclosure, withstands extreme weather and industrial conditions. Our proven experience with instrumentation, international requirements and the focus on user-friendly operation are combined in the most robust, accurate and easy-to-use field mount flow computer on the market.

Configuration

All configuration settings are accessed via a simple operator menu using the 6 button keypad or with the user friendly configuration software. Each setting is clearly indicated with an alpha-numerical description, which avoids confusing abbreviations and baffling codes. Settings are safely stored in non-volatile memory at the event of sudden power failure.

Applications

The C581 Flow & Energy Computer is designed to serve you even at harsh weather conditions and sandy environments with the more complicated jobs related to flow measurement and energy calculations. Typical applications can be found in industrial environments at heat exchangers, boilers, condensers and coolers but also in the field for complex measurement tasks. This could be with stacked differential pressure sensors or averaging systems. A basic feature of the C581 is that properties such as density and enthalpy of water and saturated / superheated steam are stored in the device.

Data logging

The logging consists of a large (8GB) register of records. Each record contains all measured and calculated values and it is stored once per minute. The log data can be visualized on the LCD with a configurable interval. It is also easy downloadable with the configuration software, even with a different interval than the display visualization.

Graphical feature overview

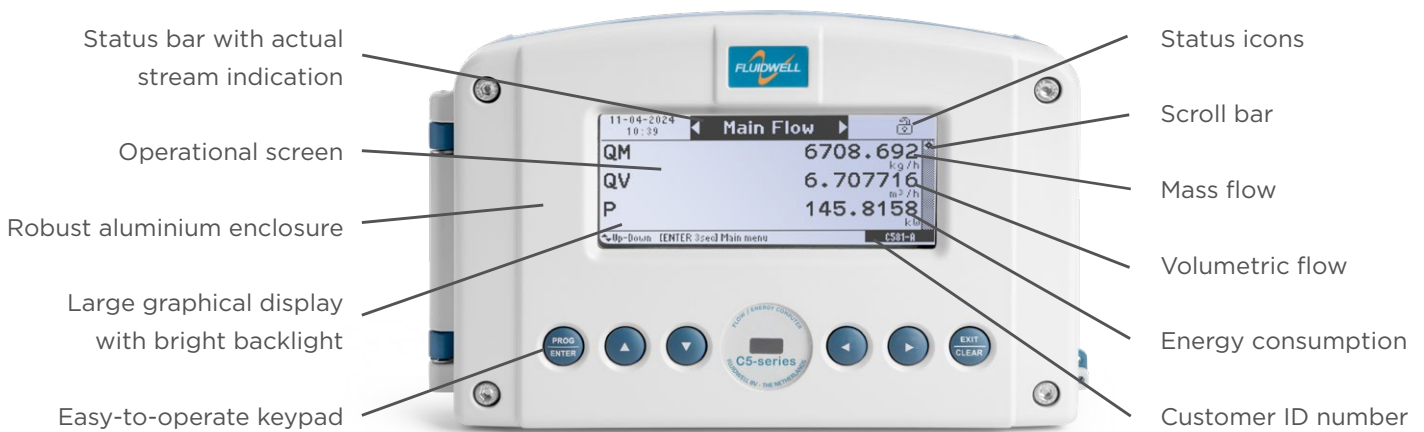

Display

The large graphical display of 121 x 52mm (4.8" x 2.0") with bright adjustable backlight shows all relevant process information at a glance. All process information (counters, flows, temperature, pressure and energy) can be displayed.

Communication

Process values and data log information can be read and settings can be downloaded and uploaded via the communication ports. The C581 contains an RS232, RS485 and a mini-USB port.



All info at a glance



Easy to install



Easy to program



Know one know them all!



Reliable



User-friendly

C581 Overview application

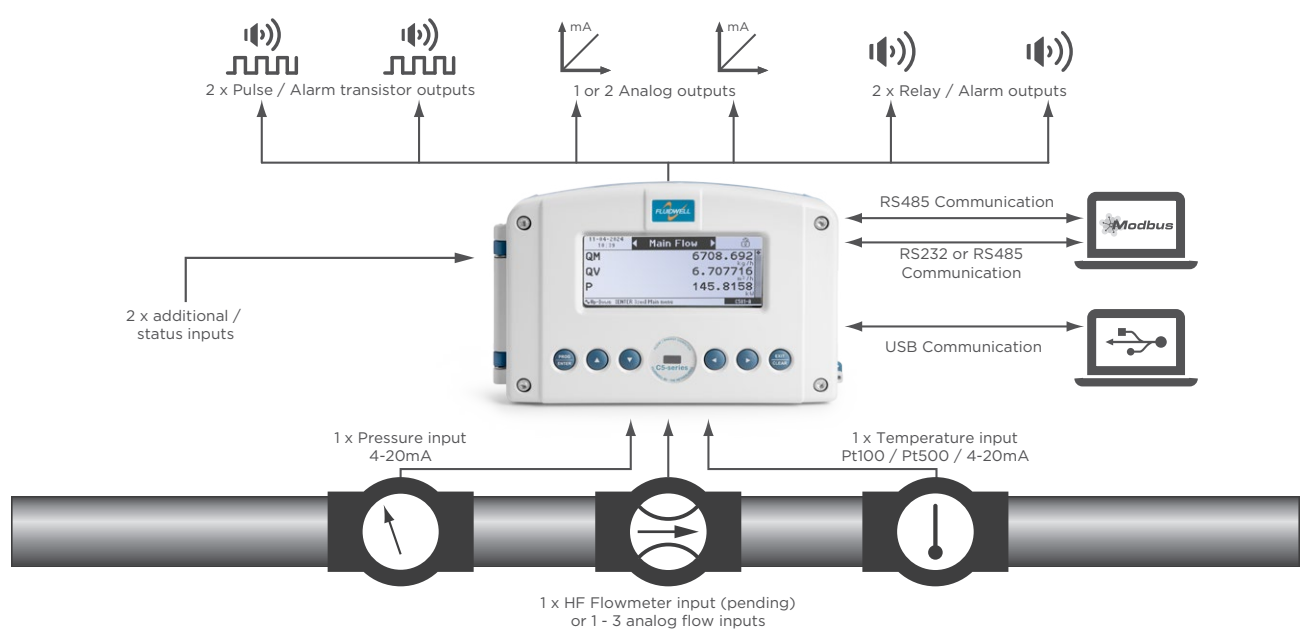

Display examples

<p>Configuration 3.3</p> <p>Main Menu</p> <ul style="list-style-type: none"> Values System settings Measurement and calc. settings Errors and warnings <p>Select menu Next menu Previous menu [EXIT] 3 sec Base screen</p>	<p>Configuration 3.3.8.4.3</p> <p>ISO 5167 Settings [Ch1]</p> <ol style="list-style-type: none"> Primary Flow Element Calibrated C Factor Calibrated Exp. Factor Flow Element Dimensions Temp. During Measurement Lin. Exp. Factor Pipe Material <p>Select menu Next menu Previous menu [EXIT] 3 sec Base screen</p>	<p>Configuration 3.1.1.1</p> <p>Values</p> <table border="1"> <tr><td>Qm</td><td>00000000.000</td><td>[kg/h]</td></tr> <tr><td>Qv</td><td>00000000.000</td><td>[m³/h]</td></tr> <tr><td>QvB</td><td>00000000.000</td><td>[Nm³/h]</td></tr> <tr><td>P</td><td>00000000.000</td><td>[kPa]</td></tr> <tr><td>P in</td><td>00000000.000</td><td>[kPa]</td></tr> <tr><td>P out</td><td>00000000.000</td><td>[kPa]</td></tr> <tr><td>P diff</td><td>00000000.000</td><td>[kPa]</td></tr> </table> <p>Select item [CLR] Previous menu</p>	Qm	00000000.000	[kg/h]	Qv	00000000.000	[m³/h]	QvB	00000000.000	[Nm³/h]	P	00000000.000	[kPa]	P in	00000000.000	[kPa]	P out	00000000.000	[kPa]	P diff	00000000.000	[kPa]
Qm	00000000.000	[kg/h]																					
Qv	00000000.000	[m³/h]																					
QvB	00000000.000	[Nm³/h]																					
P	00000000.000	[kPa]																					
P in	00000000.000	[kPa]																					
P out	00000000.000	[kPa]																					
P diff	00000000.000	[kPa]																					

Main menu

Sub menu

List of actual values

Dimensions enclosure

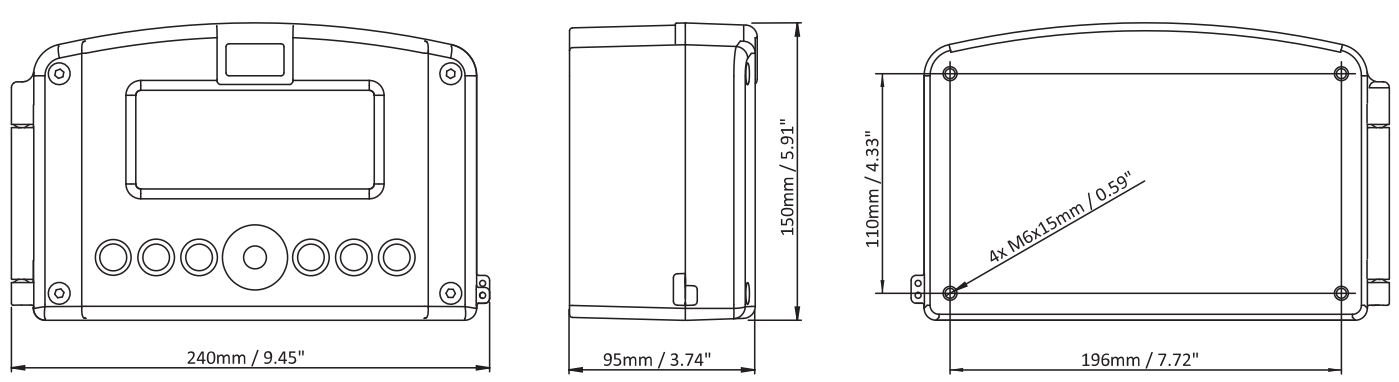

HAA Enclosure: 8 x M16+2 x M20

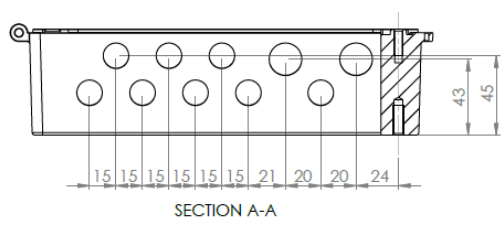

HAN Enclosure: 4 x 1/2" NPT

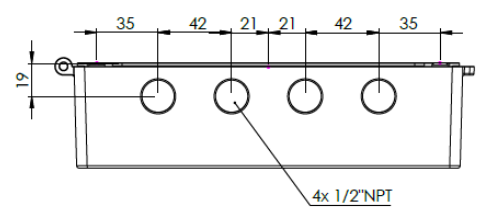

Applications examples

A cornerstone in the design of the C581 is the high usability of the product, without sacrificing user-friendliness. The C581 provides a versatile and reliable package in a strong industrial housing.

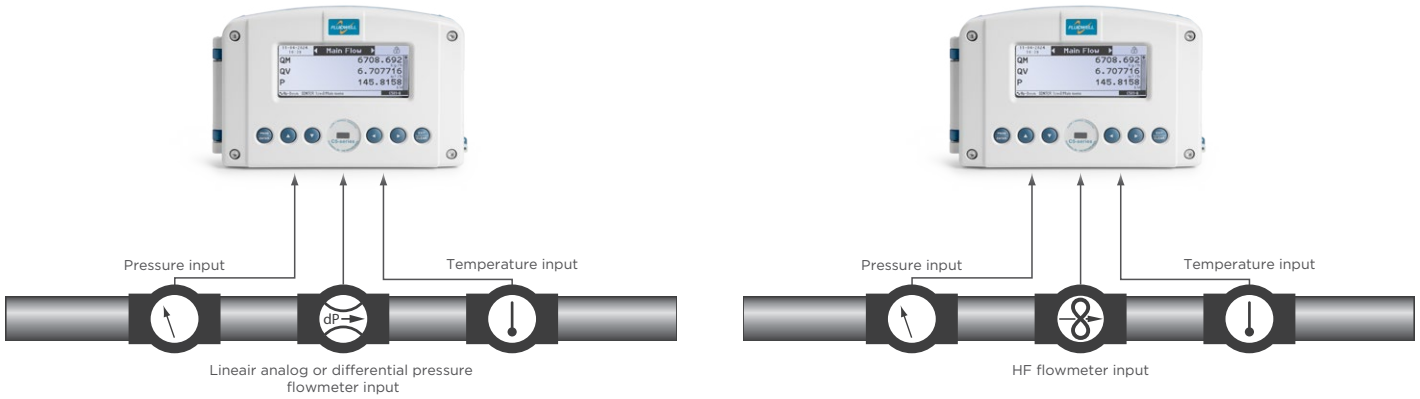

Example 1: Standard flow measurement

Measurements of a differential pressure (dP), a linear analog signal or a HF pulse generating measurement device.

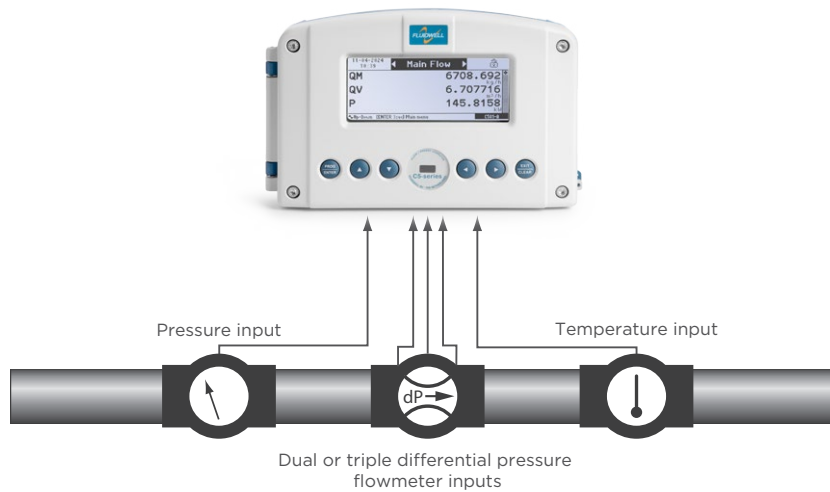

Example 2: Two- or three-stacked dP sensors at one flowmeter

Increased measurement range due to 2 or 3 overlapping differential pressure sensors over a restriction based (dP) measurement device.

Example 3: Averaging analog flowmeter

Increased accuracy due to averaging 2 or 3 analog signals. This can either be dP signals or linear flow signals.

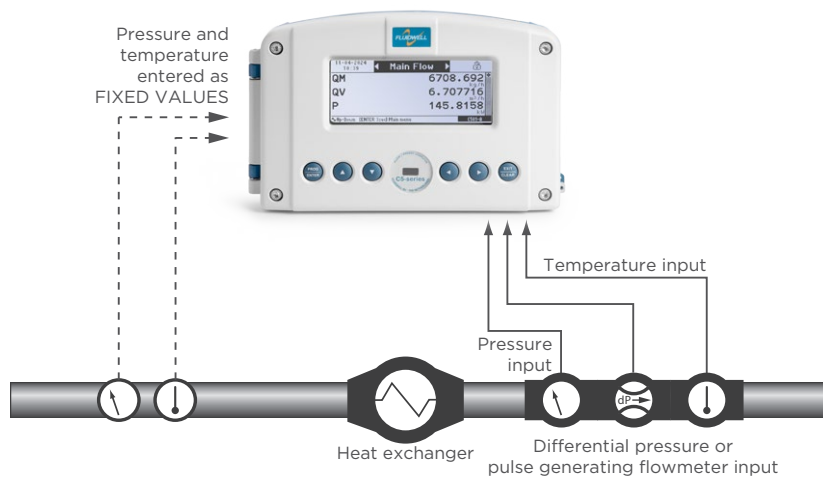

Example 4: Heat exchanger

The pressure and temperature of the inlet are entered as fixed values. The outlet flow, pressure and temperature of either the heated or the cooled fluid are measured. The C581 calculates the energy transferred by the system.

Terminal connections

TEMPERATURE INPUT

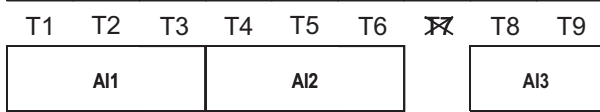

TZ: Analog passive

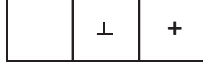

TZ: Analog active



TZ: 2-wire Pt sensor

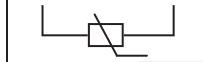

TZ: 3-wire Pt sensor

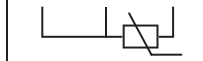

PRESSURE INPUT

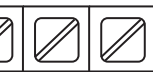

IA: Analog passive

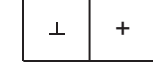

IA: Analog active



ANALOG FLOW INPUTS

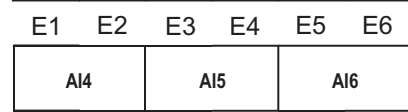

A1.1: Passive A1.2: Passive A1.3: Passive

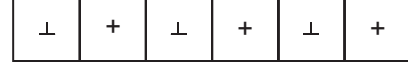

A1.1: Active A1.2: Active A1.3: Active

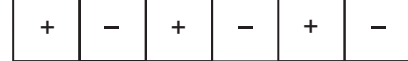

COMMUNICATION A

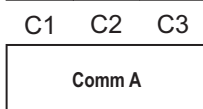

CB: RS232, isolated



CH2: RS485, isolated

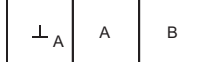

COMMUNICATION B

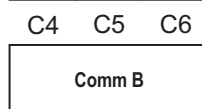

CH: RS485, isolated

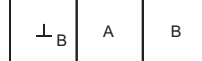

CH2: RS485, isolated

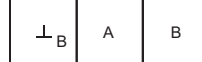

PULSE / FREQUENCY FLOW INPUT

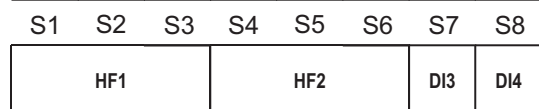
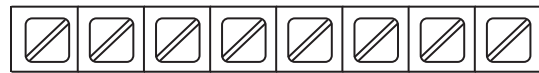

P: Coil sensor



IR: Status inputs

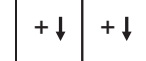

P: NPN sensor

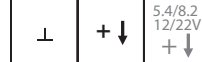

P: PNP sensor

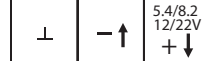

P: NAMUR sensor

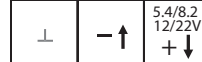

P: Reed sensor

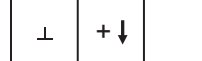

P: Active input

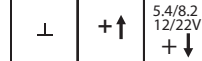

DIGITAL OUTPUTS

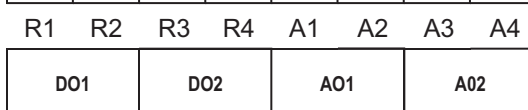

OT: Passive transistor, isolated

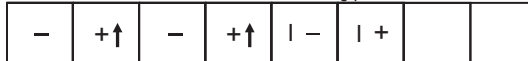

AI: Analog passive, isolated

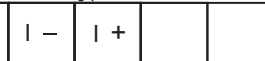

AZ: Analog active or passive isolated



RELAY OUTPUTS

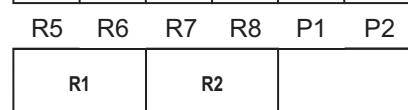
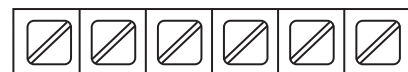

OR: Isolated SPST relay

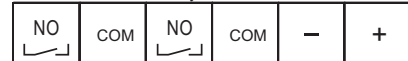

PF: 16 - 27 VDC, isolated

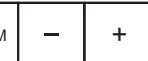

PM: 100 - 230 VAC, isolated

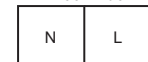

Display

Type	Large graphical display with adjustable backlight.
Dimensions	121 x 52mm (4.8" x 2.0") - 256 x 121px.
Refresh rate	5 times/sec.

Enclosure

Material	Die-cast Aluminum with Polycarbonate window.
Sealing	Silicone foam gasket.
Coating	2-component UV-resistant coating.
Control keys	Six industrial silicone keys, UV-resistant.
Environmental classification	IP66 / IP67, Type4X Environmental: A, B, C (acc. EN 1434-1:2022). Electrical: E1, E2 Mechanical: M1, M2, M3
Dimensions	240 x 150 x 95mm (6.45" x 5.91" x 3.74") - WxHxD.
Weight	2.5 kg. (5.51 lbs).
Entry threads	Type HAA: 8 x M16x1.5 and 2 x M20x1.5 Type HAN: 4 x 1/2" NPT Type HAX: Custom cable entry

Operation & Configuration

Languages	English, German, French, others are pending.
Keypad	Six industrial silicone keys, UV-resistant.
Configuration	Via keypad & display or with free PC software.

Operating conditions

Temperature	Ambient: -40°C to +55/+70°C (-40°F to +131/+158°F).
NOTE	Above +55°C/+131°F with limited sensor supply or limited use of relays.
Humidity	Max. 95% condensing.

Power requirements

Type PF	16 - 27V DC, consumption max. 12W.
Type PM	100 - 230V AC, consumption max. 12W.
Battery	Common CR2023 battery for date/clock backup.

Sensor supply

Type A	Analog inputs and outputs are supplied with >20V DC when active.
Type P	Configurable by dipswitch sensor supply. <ul style="list-style-type: none"> • 5.4V DC - Max. 60mA. • 8.2V DC - Max. 60mA. • 12V DC - Max. 60mA. • 22V DC - Max. 60mA @ >200Ohm load or 22.5V DC @ >1kOhm load.

Protection

Data protection	Non-volatile memory backup of all settings and totals. Data retention at least 10 years.
Password	Configuration settings can be password protected.
Seal	Sealable configuration switch.

Calculations

Mass	Flow rate and totalizer.
Volume	Flow rate and totalizer.
Energy	Power and energy totalizer.
Determinations	Density, enthalpy: as fixed values or table interpolated value.
Flow calculations	Pulse input: EN12405, AGA7 (pending). Analog input: Design values and ISO5167.
Property calculations	IAPWS IF-97.

Hazardous area

Zone 2	Pending.
---------------	----------

Directives & Standards

EMC	Directive 2014/30/EU, FCC 47 CFR part 15.
Low voltage	Directive 2014/35/EU
RoHS	Directive 2011/65/EU
IP & NEMA	EN 60529 & NEMA 250.

Data logging

Memory	Minimum 8GB memory for 10 year logging.
Records	5,250,000 records for 10 year logging.
Log frequency	Each record is stored once per minute with averages of all measured and calculated values.
Interval logs	Records can be visualized on the display at a configurable (real time clock) interval.
Access	Via keypad/display and configuration software.
Log download	Via configuration software and communication ports with a configurable interval (can be different then the display visualization).

Signal inputs - Flowmeter

Type P	(Pending): 1 x HF pulse input, (NAMUR, Coil, PNP, NPN, Reed sensor or active input). Like turbine meters or PD meters.
Frequency	Maximum 10kHz for total and flow rate. Maximum frequency depends on signal type and internal low-pass filter. E.g. reed switch with low-pass filter: max. frequency 120Hz.
K-factor	0.000001 - 9,999,999 variable decimal position.
Linearization	The signal can be linearized over 11 points.
Type A	3 x analog (4-20 mA) input, selectable as Active or Passive. Suitable for dP elements incl. stacked sensors (orifices, nozzles, venturies, V-cones, wedge meters, Pitot tubes, etc.) and flowmeters with a linear analog output signal.
Update time	10 times per second.
Linearization	The signal can be linearized over 11 points.
Isolation	Inputs are isolated from communication ports, the power supply and passive analog outputs.

Signal inputs - Temperature

Type TZ	1 configurable input: Pt100, Pt500 (2- or 3-wire) or analog (4-20 mA).															
4 - 20mA	Selectable as Active or Passive.															
Pt element	Selectable as Pt100 or Pt500, 2- or 3-wires.															
Moving average	Selectable between 0 - 10 seconds.															
Update time	Once per second.															
Accuracy	<table border="1"> <thead> <tr> <th>Moving average</th> <th>@0°C</th> <th>@500 °C</th> </tr> </thead> <tbody> <tr> <td>No average</td> <td>< ±0.15°C</td> <td>< ±0.35°C</td> </tr> <tr> <td>1 sec. average</td> <td>< ±0.07°C</td> <td>< ±0.15°C</td> </tr> <tr> <td>2 sec. average</td> <td>< ±0.05°C</td> <td>< ±0.11°C</td> </tr> <tr> <td>5 sec. average</td> <td>< ±0.03°C</td> <td>< ±0.07°C</td> </tr> </tbody> </table> For T _{amb.} -25..+55°C: +< ±0.0015 °C / T _{amb.} °C.	Moving average	@0°C	@500 °C	No average	< ±0.15°C	< ±0.35°C	1 sec. average	< ±0.07°C	< ±0.15°C	2 sec. average	< ±0.05°C	< ±0.11°C	5 sec. average	< ±0.03°C	< ±0.07°C
Moving average	@0°C	@500 °C														
No average	< ±0.15°C	< ±0.35°C														
1 sec. average	< ±0.07°C	< ±0.15°C														
2 sec. average	< ±0.05°C	< ±0.11°C														
5 sec. average	< ±0.03°C	< ±0.07°C														
Linearization	The signal can be linearized over 11 points.															
Isolation	Inputs are isolated from communication ports, the power supply and passive analog outputs.															

Signal inputs - Pressure

Type IA	1 x analog (4-20 mA), selectable as Active or Passive.
Accuracy	<0.05% FS, Influence Tamb. : +< ±35 ppm / °C.
Span	0.00000 / 999,999 variable decimal position.
Offset	0.001 - 9,999.999.
Update time	10 times per second.
Voltage drop	Max. 1.5 V DC @ 20mA..
Linearization	The signal can be linearized over 11 points.

Signal inputs - Status

Function	2 x configurable status inputs.
Type IR	Internally pulled-up switch contact - NPN.
Duration	Minimum pulse duration 100msec.
Isolation	Inputs are isolated from communication ports, the power supply and passive analog outputs.

Signal outputs - Digital output

Function	<ul style="list-style-type: none"> Configurable pulse outputs - selectable from a list of calculated values. Configurable alarm output.
Type OT	2 passive transistor outputs (NPN) - isolated. 50mA - 27V @ 25°C..
Frequency OT	Max. frequency 2 kHz; low level < 5V@20mA. Pulse length user definable between 0,1msec up to 1 second.
Type OR	2 Isolated electro-mechanical relay outputs (NO) Maximum load: 3A @ 250 VAC or 30 VDC resistive load. Pilot duty B300/R300. Preferred load for an extended life time: ≤ 1A.
Frequency OR	Not applicable, the relay outputs are not suitable as pulse outputs.
Note	Type OT is also included with type OR.

Signal outputs - Analog output

Function	Transmitting an analog signal for a chosen analog parameter (like flow, pressure, temp. etc.).
Type AI	1 x passive, isolated 4 - 20mA output.
Type AZ	2 x analog 4 - 20mA outputs, each selectable as passive isolated or active.
Active protection	Combined outputs: max 60 mA.
Liftoff voltage	12V.
Max. series resistance	700 ohm @ 24V DC.
Accuracy	16 bit. Error 0.05% @ 20°C (Typical 60ppm/°C). Can be scaled to any desired range.

Signal outputs - Communication

Function	Reading display info, read/write configuration settings, data log extraction. (Firmware uploads via mini-USB only.)
Type CB	<ul style="list-style-type: none"> 1 x RS232 2-wire. 1 x RS485 2-wire. 1 x mini-USB socket.
Type CH	<ul style="list-style-type: none"> 1 x RS485 2-wire. 1 x mini-USB socket.
Type CH2	<ul style="list-style-type: none"> 2 x RS485 2-wire. 1 x mini-USB socket.
Note RS485	Selectable termination resistor.
Protocol	Modbus RTU.
Speed	600 - 1200 - 2400 - 4800 - 9600 - 19200 - 38400 - 57600 - 115200.
Addressing	maximum 247 addresses.

Operator functions

Displayed info	<ul style="list-style-type: none"> Actual volume, converted volume, mass flow and power as well as accumulated totals of these values. Actual temperature, pressure, density, enthalpy or specific heat and reference values. Data log records. Settings and configuration details. Errors and warnings.
-----------------------	---

Supervisor functions

Displayed info	<ul style="list-style-type: none"> All operator info. The number of lines at the base screen can be set: 3, 5 or 7 lines. "CONFIGURATION" is displayed in the menus.
Actions	<ul style="list-style-type: none"> All configuration parameters can be set. Changes can be applied when the (sealable) configuration switch is in the "enable" position, when the password (when enabled) is entered or with the configuration software connection on a PC.

Mass flow

Indication	QM.
Units	kg/h, kg/day, kg/min, kg/s, g/h, g/min, g/s, ton(m)/day, ton(m)/h, ton(m)/min, ton(m)/s, lb/day, lb/h, lb/min, lb/s, ton(sh)/h.

Volume flow

Indication	QV.
Units	m ³ /h, m ³ /day, m ³ /min, m ³ /s, l/h, l/min, l/s, ACF/h, ACF/min, ACF/s, MACF/h, MMACF/day, Gal(US)/day, Gal(US)/h, bbl(US)/day, bbl(US)/h.

Power

Indication	P.
Units	kW, Mw, W, HP(m), cal(th)/s, kcal(th)/h, BTU(th)/h.

Mass total

Indication	M.
Units	kg, g, ton(m), lb, ton(sh).

Volume total

Indication	V.
Units	m ³ , l, ACF, MACF, MMACF, Gal(US), bbl(US).

Energy

Indication	E.
Units	kWh, MWh, J, kJ, MJ, GJ, cal(th), kcal(th), BTU(th).

Temperature

Indication	t.
Units	°C, K, °F, °R.

Pressure

Indication	p.
Units	kPa, Pa, MPa, bar, mbar, psi, mH ₂ O (4°C), Torr, At, Atm, kgf/cm ² , lbf/in ² , lbf/ft ² .

Density

Indication	Rho.
Units	kg/m ³ , kg/l, g/m ³ , ton(m)/m ³ , lb/in ³ , lb/ft ³ , lb/Yd ³ , lb/Gal(US), ton(sh)/Yd ³ .

Enthalpy

Indication	H.
Units	kJ/kg, MJ/kg, kcal/kg.

Accessories

ACE01	USB cable for PC configuration and data log extraction, mini USB to USB. (2.0m / 6.7ft).
AMC01	Stainless steel 304 wall mounting kit.
AMC02	Stainless steel 304 pipe mounting kit (worm gear clamps not included).
AMC03	Stainless steel 304 DIN rail mounting kit.
AMC04	Stainless steel 304 protective sun & rain shed + wall mounting kit.
AMC05	Stainless steel 304 protective sun & rain shed + pipe mounting kit (worm gear clamps not incl.).
ACF06	Two stainless steel worm gear clamps D=44 - 56mm (1.73" - 2.20").
ACF07	Two stainless steel worm gear clamps D=58 - 75mm (2.29" - 2.95").
ACF08	Two stainless steel worm gear clamps D=77 - 95mm (3.04" - 3.74").
ACF09	Two stainless steel worm gear clamps D=106 - 138mm (4.18" - 5.43").
AGB02	Nickel-plated brass cable gland M16 x 1,5, EMC-compatible, for cable diameter 3 - 7mm and with dome plug to seal the entry.
AGB03	Nickel-plated brass cable gland M20 x 1,5, EMC-compatible, for cable diameter 7 - 12mm and with dome plug to seal the entry.
AGB05	Nickel-plated brass cable gland 1/2" NPT, EMC-compatible, for cable diameter 6 - 12mm and with dome plug to seal the entry.
AGB06	Nickel-plated brass cable glands for HAA: 8 x M16 and 2 x M20, EMC-compatible, with dome plugs to seal the entries.
AGB07	Nickel-plated brass cable glands for HAA: 4 x 1/2" NPT, EMC-compatible, with dome plugs to seal the entries.
ABV01	Protective vent/Breather valve M12+reducer M16.
ABB09	Nickel-plated brass blind plug M16 x 1,5.
ABB10	Nickel-plated brass blind plug M20 x 1,5.
ABB12	Chrome blind plug 1/2" NPT.

		Description
Model	C581	Single stream Flow & Energy Computer for water and saturated / superheated steam
Flow	A	3 analog inputs (active / passive)
	P	1 pulse input (pending)
Analog	AI	1 passive isolated analog output
	AZ	2 configurable analog outputs (active / passive isolated)
Communication	CB	1 x RS485 2-wire Modbus communication & 1 x RS232 communication
	CH	1 x RS485 2-wire Modbus communication
	CH2	2 x RS485 2-wire Modbus communication
Media	ES	Flow equations for water and steam (saturated / superheated)
Enclosure	HAA	Aluminum field mount enclosure; Cable entry: 8 x M16 and 2 x M20
	HAN	Aluminum field mount enclosure; Cable entry: 4 x 1/2"NPT
	HAX	Aluminum field mount enclosure; Custom cable entry
Additional	IA	Analog 4 - 20 mA input for pressure signal (active / passive)
	IR	2 status inputs
Digital	OR	2 configurable relay outputs and 2 configurable passive transistor outputs
	OT	2 configurable passive transistor outputs
Supply	PF	16 - 27V DC + sensor supply
	PM	100 - 230V AC + sensor supply
Temp.	TZ	Pt100 / Pt500 or analog 4 - 20 mA temperature input
Area	XX	Safe area only
Options	ZB	Adjustable backlight
	ZL	Data logging

The **bold** marked text contains the standard configuration: C581-A-AI-CH-ES-HAA-IA-IR-OT-PM-TZ-XX-ZB-ZL.